

International Conference on Space Optics—ICSO 2022

Dubrovnik, Croatia

3–7 October 2022

Edited by Kyriaki Minoglou, Nikos Karafolas, and Bruno Cugny,

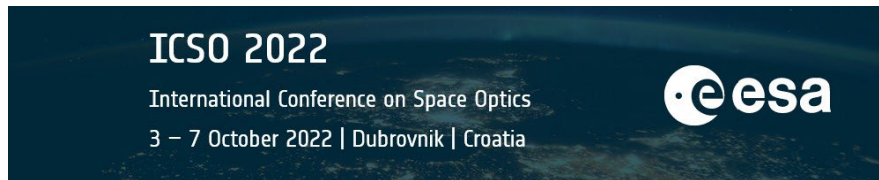

STATUS OF AEOLUS-2 MISSION PRE-DEVELOPMENT ACTIVITIES



STATUS OF AEOLUS-2 MISSION PRE-DEVELOPMENT ACTIVITIES

Arnaud Heliere, Denny Wernham, Graeme Mason, Thorsten Fehr - European Space Agency,
Geraud De Villele, Bertrand Corselle, Olivier Lecrenier, Thomas Belhadj, Paolo Bravetti,
Sylvain Arnaud, Didier Bon, Philippe Lingot, Roland Foulon, Denis Marchais, Mickael Olivier -
Airbus Defence and Space SAS,
Alessandro D'Ottavi, Fulvia Verzeznassi, Alessia Mondello, Francesco Coppola, Guglielmo
Landi-Leonardo Spa,
Hans-Dieter Hoffmann, Dominik Esser - Fraunhofer-Institut für Lasertechnik (ILT),
Lucia Perez Prieto, Christian Wührer - Airbus Defence and Space Gmbh,
Christopher Rivers, Ray Bell Teledyne E2V

ABSTRACT

The European Space Agency's (ESA) Aeolus satellite was launched on 22 August 2018 from Centre Spatial Guyanais in Kourou, French Guyana. The Aeolus data has been extensively analysed by a number of meteorological centres and found to have a positive impact on NWP forecasts, particularly in the tropics and polar regions. These positive results, along with the successful in-orbit demonstration of the measurement concept and associated technologies utilised on Aeolus, resulted in a statement of interest from EUMETSAT in a future, operational DWL mission in the 2030 to mid-2040's timeframe and a request to ESA to carry out the necessary pre-development activities for such a mission. This paper will describe the current status of instrument pre-development activities that are being performed in the frame of a potential Aeolus-2 mission. The main inputs for a future Doppler Wind Lidar (DWL) instrument that have been used are: lessons learned from the Aeolus development phases and the in-orbit operations and performance; initial inputs from EUMETSAT including a total mission lifetime of higher than 10-15 years utilizing 2 spacecraft (implying a lifetime of 5.5 years for each) with a launch of the first satellite in 2030, increased robustness and operability of the instrument, and an emphasis on reduction of recurrent costs; the maximum utilization of the demonstrated design heritage; and a number of recommendations for the requirements of a future DWL mission from the Aeolus Scientific Advisory Group (ASAG). These inputs have been collated and combined into a set of preliminary requirements which have been used as the basis for a dedicated Instrument Consolidation Study. An extensive review and trade-off of the above inputs by Airbus Defence & Space, ESA, and independent experts, resulted in the decision to baseline a bi-static instrument design. In addition, three instrument subsystem pre-development activities are currently running: two laser transmitter pre-developments and the pre-development of an improved detector. These developments have the aim to demonstrate that issues identified from the above are resolved and that the technology levels are sufficiently mature for the follow-on DWL mission. The status of these pre-developments will be summarised.

Keywords: Aeolus-2, Aeolus, winds, DWL, NWP, atmospheric dynamics, Lidar

1. INTRODUCTION

The European Space Agency's (ESA) Aeolus satellite was launched on 22 August 2018 from Centre Spatial Guyanais in Kourou, French Guyana. The Aladin instrument, the sole payload on Aeolus, is the world's first spaceborne Doppler Wind Lidar (DWL), providing profiles of horizontal line-of-sight (HLOS) wind retrievals to be used as Numerical Weather Prediction (NWP) model inputs in order to improve short to medium range forecasts [1]. The Aladin instrument has been continuously operating for 4 years (with around 2 months of non-operation due to an unexpected timing synchronization error on the satellites GPS unit which put the instrument into Standby Mode, and the switch from the first to the second flight laser transmitter). The Aeolus data has been extensively analysed by a number of meteorological centres and found to have a positive impact on NWP forecasts, particularly in the tropics and polar regions [2]. This has led to the operational assimilation of Aeolus data by the European Centre for Medium Range Weather Forecasting (ECMWF), Deutscher Wetterdienst (DWD), Meteo-France and the UK Met Office. These positive results, along with the successful in-orbit demonstration of the measurement

concept and associated technologies utilized on Aeolus, resulted in a statement of interest from EUMETSAT in a future DWL mission and a request to ESA to carry out the necessary pre-development activities for such a mission.

2. AEOLUS DEVELOPMENT AND IN-ORBIT LESSONS LEARNED

Despite the positive impacts on NWP reported above, a number of performance issues on the Aladin instrument were identified which are required to be resolved in any future DWL mission [3]. The initial atmospheric return signal levels were lower by a factor of around x2 lower than expected causing an increase of the random error for the wind measurements. The UV energy output of the first flight laser at the beginning of operation was lower than expected from ground measurements by around 20% (65mJ versus 80mJ) and showed a continual monotonic degradation in output with time of operation, of around 40% in 9 months, associated with a gradual misalignment of the laser pointing. The second flight laser had much improved performance with around 70mJ output energy at the beginning of operations and has remained over 60mJ over 3 years operations and is currently operating around 90mJ. Nevertheless, there has been an important degradation of the atmospheric return signal (not associated with the laser output energy) from the beginning of operations of the second flight laser. As both the UV energy reduction of the first flight laser during operations and the evolving return signal at constant laser energy were associated with long term evolutions of the laser beam pointing, it was deemed necessary to improve the overall long term stability of the transmitters (which also introduces an evolution in the measurement bias which needs to be corrected) for a follow-on mission. The atmospheric path degradation can only be partially explained by beam misalignments, and there is an additional contribution due to radiometric losses within the optical emission path of the instrument i.e. between laser output and the telescope. This loss, which could be due to long term Laser-Induced Contamination (LIC), Laser-Induced Damage (LID), or the darkening of optics due to activation of colour centres, was one of the major drivers to go from a monostatic (transceiver) design to a bi-static design in order to increase the robustness of the instrument.

Significant changes in the bias associated with discrete altitudes was identified by ECMWF in the Level-2B data early in Aeolus operations. These were found to be caused by elevated background signal levels on individual pixels on the Aeolus Accumulation Charge Coupled Devices (ACCDs). Although a workaround solution was found using an increased number of background corrections for the ACCDs, it was judged necessary to resolve these issues with a dedicated detector development. Large fluctuations in the measurement bias and radiometric performance were also evident on sub-orbital timescales. This was found to be associated with thermal variations of the Aladin 1.5m diameter primary mirror and the resulting changes in wavefront caused by changing albedo levels. These effects are exaggerated by the limited Field of View (FoV) of the receiver, defined by the 80 μ m diameter (18 μ rad) instrument field stop. These are currently corrected using a correlation with the ECMWF model wind data using data from other sources but, in principle, can also be corrected with ground return zero wind calibrations with sufficient signal to noise levels.

As far as the Aeolus development was concerned, major technology issues were found on the resistance of the laser and emission path optics to LID, and LIC particularly in the UV and under reduced pressure, or vacuum operation of the laser [4]. These operational conditions also resulted in gradual changes in the thermal conductance of the amplifier interfaces to the laser cooling system, in turn resulting in drifts in the laser master oscillator alignment. In Aladin, successful solutions were found to the above by developing high damage threshold, high density optical coatings and the inclusion of a dedicated in-situ cleaning system (ICS) which provides the optics in the laser and emit path of the instrument with low pressures of oxygen (50-100Pa) in order to avoid LIC. The low pressure operation however, results in continuous electrical discharges from the high voltage Q-switch in the laser master oscillator and does not prevent the laser pointing instabilities which are clear risks for increased lifetime operations.

Due to the above, the original baseline operation of the Aladin instrument in vacuum directly led to a significant delay of several years in the instrument development and eventual Aeolus launch. This led to the decision to pressurise the Aladin laser on EarthCARE which also applies to future missions with high power lasers (including Aeolus-2). For the above reasons, it was judged necessary to have 2 separate laser transmitter pre-developments at Leonardo (Aladin and Aladin laser transmitter heritage) and The Fraunhofer Institute for Laser Technology (ILT with laser transmitter heritage on FULAS and MERLIN) in order to reduce the risk of delays in the transmitter delivery for the follow-on mission. In addition, the laser will be pressurised in order to avoid the major technology issues encountered on Aladin. A key input to the laser transmitter suppliers was to otherwise retain the heritage of their previous laser designs as far as possible to reduce development risks.

3. AEOLUS-2 REQUIREMENTS

3.1. EUMETSAT

As stated previously, the initial inputs from EUMETSAT defined a follow-on mission for 2-3 satellites with a 10-15 year lifetime with a proposed launch of the first satellite in 2030, meaning a minimum lifetime of 5 years for each spacecraft and a relatively short development timescale for the first satellite compared to previous developments of instruments with high power lasers. This 5 years lifetime should be compared to the 3 years lifetime of Aladin. This increase in lifetime has important consequences for the follow-on instrument. Firstly (and also as part of the mitigation for the initial low atmospheric return signal levels on Aladin), the laser UV energy output needs to be increased from the 60-70mJ on Aladin to more than 125 mJ. It was assessed that the current laser technologies can be scaled to attain these higher UV energies (indeed the Aladin lasers have already demonstrated operation at these energies on ground but had to be de-rated in order to avoid damage of optics in the emit path of the instrument which unfortunately could not be retrofitted with the best laser optics technology).

The 2030 launch of the first Aeolus-2 satellite also imposes constraints on the development logic and necessitates the need to maximise the Aladin heritage and design recurrence as far as possible, and to closely control and monitor any design changes which are deemed necessary. Additionally, when coupled with the long design timescales for previous laser transmitters, it was clear that the transmitter pre-developments should be initiated as soon as possible as these historically drive the overall satellite schedule. This approach also maximizes the potential to eventually reduce the recurrent costs for the subsequent satellites which was a specific request from EUMETSAT.

3.2. Mission requirements from the Aeolus Science Advisory Group

The Aeolus Science Advisory Group (ASAG) have, taking account of the science impact of Aeolus as well as the assumed future needs for NWP inputs, provided a number of recommendations for the performance of a future DWL [4]. These include an extension of the altitude for the measurements from 20km to 30km with a relaxation on the random error requirement from 3 to 5m/s at the higher altitudes; an increase in the number of vertical bins from 24 to a minimum of 54 and vertical sampling resolution from 1km to 500m in the free troposphere, from 500m to 250m in the Planetary Boundary Layer (PBL), and from 2km to 1km in the lower stratosphere; a horizontal observation resolution of <100km to <50km in the PBL and free troposphere; a dynamic range increase for the wind speed measurement from ± 100 m/s to ± 150 m/s; a recommendation to introduce a cross-polar channel in order to retrieve the full particle backscatter signal. These changes to the resolution requirements imply that the low signal return anomaly observed for Aladin is resolved and in addition, the signal return is increased by at least a further factor of x2 compared to Aladin which is clearly challenging.

Table 1. Preliminary main user requirements for Aeolus 2.

		PBL	Troposphere	Stratosphere
Vertical domain	km	0-2	2-16	16-30 (40)
Vertical Resolution	km	0.5 (Mie)	1.0 (Rayleigh & Mie)	2.0 (Rayl&Mie)
Threshold		0.25 (Mie)	0.5 (Rayleigh & Mie)	1.0 (Rayl&Mie)
Breakthrough				
Number of vertical samples		> 54 (per channel)		
Threshold		> 75 (per channel)		
Breakthrough				
Horizontal observation resolution	km	100	100	200
Threshold (Rayleigh)				
Precision (random error)	m/s	2	2.5	5
Systematic error (bias)	m/s	1		
Threshold		0.5		
Breakthrough				
Dynamic range	m/s	± 120 (± 150)		
Timeliness	hour	3		
Threshold		1		
Breakthrough				

The Aeolus Science Advisory Group (ASAG) also expressed interest in implementing an aerosol cross-polar channel, which would allow to retrieve in addition to wind products, also aerosol and cloud backscatter and depolarization properties.

4. FIRST ITERATION OF AEOLUS-2 INSTRUMENT DESIGN

The Aeolus-2 instrument benefits from the Aladin instrument heritage in Airbus Defence and Space who was responsible for its design, development, integration and test[5]. The updated configuration for Aeolus-2 targets to minimize new developments and all risk areas. This section illustrates specific design features from Aeolus-2 instrument and justify their selection from lessons learnt or from new requirements.

4.1. Bi static design approach

As previously mentioned, the selected design is a bi-static which means that the transmitter (Tx) side is separated from the receiver (Rx) side. The emitted high fluence beam optics are not common with the receiver side.

This choice is motivated by the lessons learnt on Aladin and other LIDAR programs: high fluence optics are at risk and a potential single point failure for the instrument.. The segregation of transmitter side with high fluence optics from the receiver side significantly decreases this risk. The transmitter side with high fluence optics is fully redundant in the bi-static configuration with two completely separated emit paths. In addition all the pressurization of the high fluence optics would have been complex to install in the monostatic design with common receive and transmit optics.

The following figure Figure 4-1 show the optical sketch of the instrument. The separation of the transmitter path from the receiver path requires the usage of a co alignment system that maintain both Tx and Rx aligned over mid-term scale to avoid to degrade instrument performance.

For that purpose a co-alignment sensor is placed on the receiver and monitor the beam atmospheric echo Line of Sight (LoS) error and react on a beam steering mechanism that correct the emission beam line of sight accordingly.

This technique is inherited from Atlid Lidar which is also bi-static design [6].

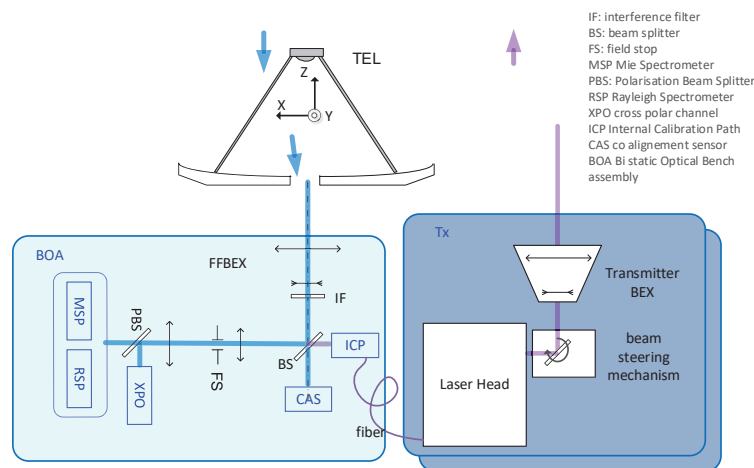

Figure 4-1 Aeolus-2 instrument optical schematic

4.2. Receiver design

The receiver design function is similar to Aladin one, but simpler as the transmitter path is not present. The two spectrometers principle for Mie and Rayleigh backscattering Doppler frequency shift measurement is identical to Aladin in baseline benefiting from the large data accumulated in orbit.

The first new feature is the co-alignment sensor which will constantly image the atmospheric echo allowing to better assess performance and co-align the Tx / Rx in the bi-static configuration.

The second one is the presence of cross polar channel which is quite easily inserted in the bi-static receiver optical path thanks to a beam polarization splitter.

The detection requirements have been updated to match the requirement for a minimum of 66 vertical layers instead of 24 used for Aladin.

4.3. Transmitter design

The transmitter design is inherited from the Atlid architecture principle, with a beam expander and a beam steering mechanism that allows to decrease Tx divergence and co align the Tx beam LoS to the Rx respectively.

The transmitter energy has been increased from the 60 - 100mJ for Aladin in orbit to the 125mJ end of life target over 5 years. A major challenge for the transmitter is certainly its reliability and its emission stability from spatial and spectral point of view.

The instrument design is oriented to be compatible for both the lasers studies described in section 5.

4.4. Overall design accommodation

Figure 4-2 shows the preliminary accommodation. The bi-static architecture has two side emission beam expanders which are independent from the main telescope.

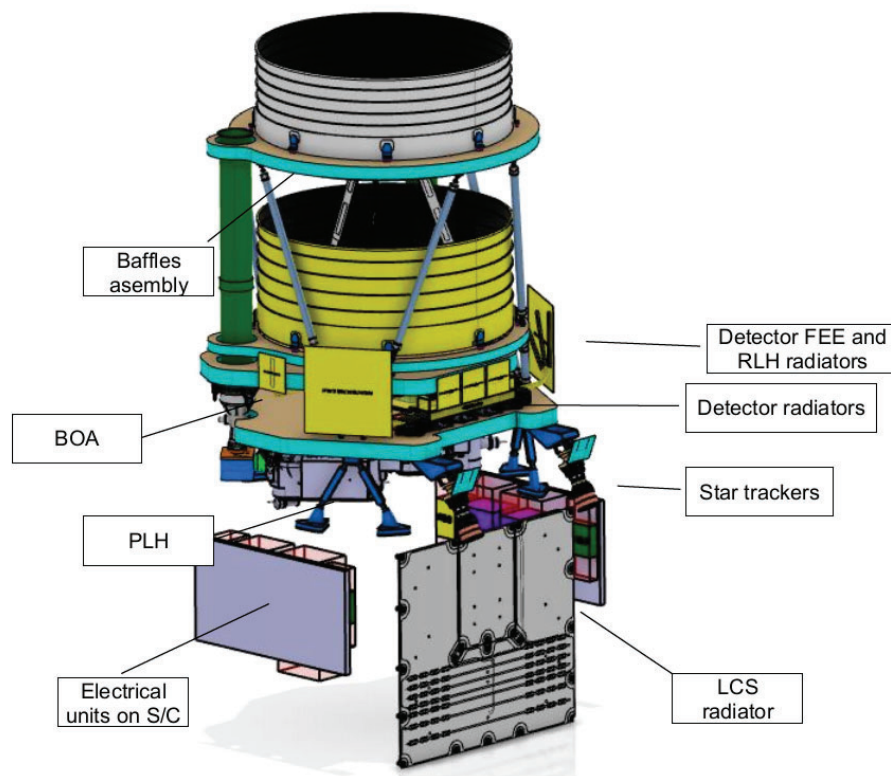

Note: LCS: laser cooling system, PLH: Power laser head, BOA: bi static optical assembly, FEE: front end detector

Figure 4-2 Aeolus-2 instrument preliminary accommodation

The laser transmitter bi-compatibility, required for the instrument, is ensured via the use of a dedicated panel for the lasers interface offering better accommodation flexibility.

The current instrument mass assessment is about 860kg (including development margins). The increased mass from the Aladin instrument is mainly linked to the laser mass being about 30% of instrument mass: pressurized laser, different housing volume. Other contributors are linked to the bi-compatible architecture with larger laser head dimensions, as well as telescope design updates aiming at minimising the wave front error variations and induced wind bias errors.

5. INSTRUMENT PRE-DEVELOPMENTS

5.1. Leonardo Laser pre-developments

The laser proposed by Leonardo (LDO) for the Aeolus 2 mission is a direct evolution of the Aladin and Atlid laser transmitters. Both lasers are based on a MOPA (Master-Oscillator Power-Amplifier) configuration but the former integrates two amplifiers whilst the latter has a single amplifier stage. The Aladin laser works with a low pressure of molecular oxygen (around 40Pa) used to prevent LIC while the Atlid transmitter is a sealed unit operated at 1.2 bar of hyper-pure air.

Even if the energy level required for the Aeolus mission is lower than the one requested for Aeolus-2, the Aladin laser is able to reach the energy requirement of the latter with a reasonable margin, without any major modifications, as demonstrated during the integration of the flight models. For example, the FMB laser reached an UV output energy greater than 180mJ. The frequency stability of the laser can also be realized with the Aladin design. In addition, recent measurements performed on a representative Bread Board (BB) (realized to test the laser optical improvements to be implemented in Aeolus-2) showed a very good beam quality at IR amplifier and UV output, which ensures the fulfillment of the one of the most critical performance requirements in Aeolus-2, namely the low divergence at UV output. On the other side, the Atlid laser transmitter is pressurized (as requested for the Aeolus-2 transmitter) and its thermo-mechanical design solved one of the major design weaknesses of the Aladin laser for where the thermal and mechanical interfaces were located on the same surface.

For both the Aladin and Atlid laser transmitters, six-month endurance tests have been run to demonstrate the behavior of the lasers over the longer term. One of the most important results is that degradation of the optical output, if any, can be ascribed to the ageing of the laser diodes which can be easily recovered acting on the laser diode current. Visual inspections performed at the end of the tests on both Aladin and Atlid TXA units have not revealed any major evidences of LIC, confirming that the rules applied for the selection of materials and processes, coupled with the operation in an oxidizing environment ensure the absence of significant levels of LIC inside the LDO transmitters.

As far as the lifetime is concerned, the Aladin FMB has demonstrated 3 years of continuous functioning with only a minor degradation which was easily compensated by acting on timing or current settings and the UV output energy at the time of writing is around 100mJ. The extension to 5-year lifetime seems achievable by the Aladin laser diodes technology but this issue is definitively resolved using the Laser Diodes developed for the Atlid mission, which are capable of withstanding 5-7 years of continuous operations. Delta qualification campaigns will be required for a limiter number of elements, thanks to the extensive heritage from the Aladin and Atlid projects and confirmed by the excellent results reached in orbit by the Aladin transmitter.

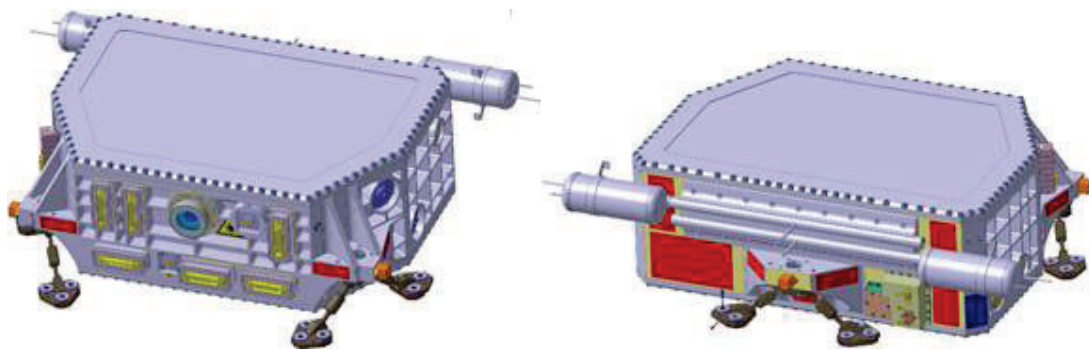

Figure 5.1-1: Front and rear view of the LTA for Aeolus 2 mission developed by LDO

The Aeolus-2 laser design is based on the well-demonstrated layout of the previous lasers. The amplifier section is based on amplifiers developed by Lumibird that have demonstrated an excellent reliability in flight.

Improvements are foreseen in the harmonic conversion sections via an accurate selection of the crystal geometry. Considering the results obtained in Atlid and Aladin, LDO is confident that the optimization can be achieved.

An initial co-engineering phase with the Airbus instrument team has allowed the definition of guidelines for a design in line with the instrument needs. The Aeolus-2 laser is compatible with the new thermal interface based on a single medium heat pipe. Power consumption, mass, and beam output performances are in line with the future transmitter requirements. The laser head will incorporate image sensors to allow an accurate evaluation of the laser status in flight. In the meantime, two physical models (a Bread Board(BB) and an Engineering Model (EM) unit) have been developed. The BB unit has been used to assess the possibility to enhance the performance of the IR section with a gain of IR energy of about 15% for the same power consumption. The new configuration could be implemented should an extra energy budget be needed. Tests at harmonic section level are foreseen in the next months to consolidate the budget figures and to demonstrate the feasibility of the generation of the output UV energy. The EM is under realization; the bench has been finalized as well as almost all of the assemblies of the master oscillator. Currently LDO is engaged in the development of the remaining parts in order to integrate a complete transmitter within the conclusion of the Aeolus-2 predevelopment phase.

5.2. ILT-Airbus DS Laser pre-developments

The Fraunhofer Institute for Laser Technology (ILT)-Airbus Defense and Space (DS) laser concept for an Aeolus-2 mission is based on the heritage of the Merlin (Methane Remote Sensing LIDAR Mission) and FULAS (FUture LASer) technology demonstrator for a space-borne Laser transmitter. The laser design incorporates more than 30 years of experience on ILT side in the development of laser technologies and the extensive know how of Airbus DS in optical systems for operation in space.

FULAS was developed as an elegant, flight-like technology demonstrator on the basis of the original Atlid requirements. The Merlin Engineering Qualification Model (EQM) is currently being integrated, and the qualification of all core underlying technologies has been successfully achieved. The components and sub modules such as the frequency converter (OPO) for the MERLIN EQM and Flight Model (FM) have been manufactured and qualified, and are ready for integration.

Both laser designs rely on key concepts that address specifically the concerns and lessons learned raised by the first Aeolus mission:

- All laser components are mounted onto a monolithic optical laser bench (the LASO) with ultra-stable mounting technology, ensuring high stability of the alignment from ground-to-orbit and over the complete mission lifetime,
- The thermal management system and the mechanical structure are decoupled from each other,
 - o The LASO bench is mounted into the laser housing (the LASH) via kinematic mounts, which effectively decouple it mechanically (and thermally) from the housing ensuring that any external mechanical disturbances are not transferred to the alignment-critical laser elements,
 - o Heat removal from the laser components is performed via a heat-pipe system, which removes the heat directly from the sources. In this way thermal gradients in the baseplate and their impact on the mechanical stability of the system are minimized,
- The laser housing itself is pressurized and filled with synthetic air in order to cope with LIC and Laser-Induced Damage(LID),
 - o All optomechanical and electrical components are free of organics such as glues or plastics. This outgassing free concept is essential for ensuring the life time of the high power laser system and especially of the UV optics in sealed housing.

Figure 1 shows the main components of the proposed Aeolus-2 laser design:

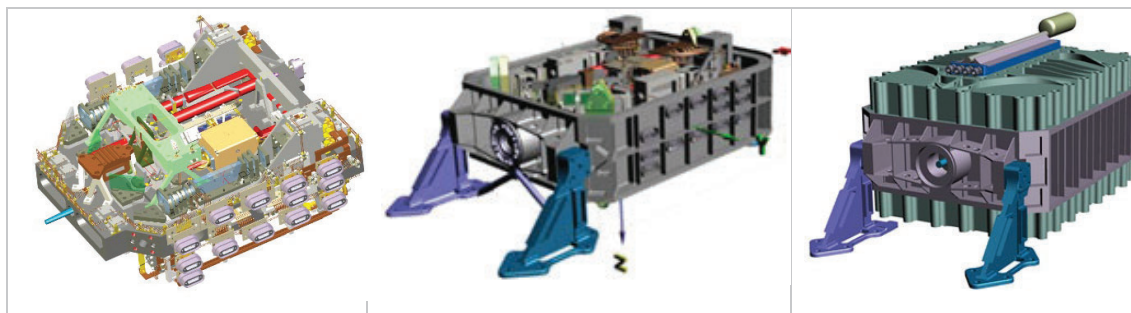

Figure 5.2-3: Left: LASO bench view on power amplifier and UVsection. Middle: LASO bench integrated into LASH (w/o cover). Right: closed housing with interface to payload loop-heat-pipe in the upper cover.

While relying strongly on heritage, a number of modifications have been introduced with respect to Merlin and FULAS, mainly to scope and optimize the higher laser output power required and its associated impact.

The oscillator and the INNOSLAB preamplifier of the transmitter is based on the FULAS design. A second INNOSLAB amplifier is used to scale the laser energy to about 450mJ. With a breadboard of this setup ILT has demonstrated more than 500mJ pulse energy at 100Hz pulse repetition frequency. Because of the power and mass budget limits of the instrument the Aeolus-2 transmitter will be operated at 50Hz.

For Aeolus-2 a higher laser energy of 150mJ in UV at low fluence in the UV path is required. ILT has adapted the dimensions of existing UV converters for providing reliable long term operation. Its proprietary simulation software OPT has been applied to identify a design optimized with respect to high conversion efficiency at minimized UV fluence.

In the LASH domain, the thermal control system has been optimized for the higher thermal loads while at the same time reducing integration and verification complexity. While in FULAS and Merlin an internal mini-loop-heat-pipe system was used to transport the heat loads, the Aeolus-2 concept foresees a copper-water heat-pipe cooling system, with higher thermal conductance.

As part of the Aeolus-2 predevelopments, ILT and Airbus DS are building an EM of the proposed design. This demonstrator will undergo a TV-test campaign to demonstrate its performance and suitability for an Aeolus2 mission. The campaign will include a full characterization of the laser before and after thermal cycling and exhibition to vacuum environment. It will provide information on the impact of non-operational and operational temperatures on the laser performance. For testing the long term behavior an endurance test is planned. The main procurements have been triggered ahead of the Detailed Design Review, which will take place in Q4 2022.

The EM activities are complemented by additional measurements on existing breadboards and demonstrators which are representative of the proposed technologies.

- At present, the existing Aeolus-2 breadboard is being completed by ILT to include the UV converter. A measurement campaign is planned to be conducted later in 2022.
- The FULAS demonstrator follows the principle of decoupling thermal and structural design. A test campaign is ongoing to demonstrate the robustness of this concept against variation of the thermal loads generated by the laser and temperature variations at the interfaces. The first results are available and summarized in Figure 2. The laser output energy, pointing and divergence are shown to be extremely robust against temperature variations. It is worth noting that no re-alignment or re-adjustment of the operational set-point of the FULAS laser has been required, even after over seven years of operation and storage. This underlines the set-and-forget principle which is a key asset of the proposed design.

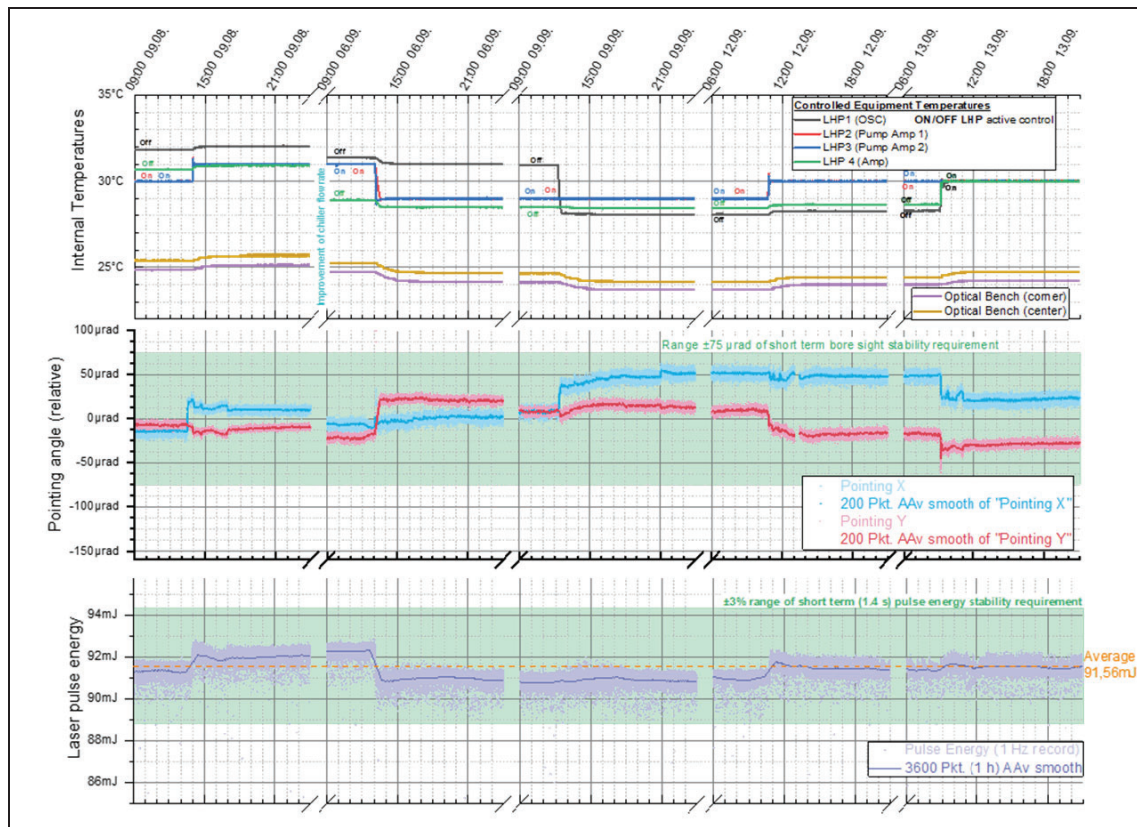

Figure 5.2-4: Measurement results of the ongoing FULAS campaign. Laser output energy and pointing remain highly stable.

5.3. Detector pre-development

Teledyne e2v designed and built the original CCD69 ACCD for the Aladin instrument. As previously stated, elevated background signal levels were found on individual pixels (“hot pixels”) whilst in flight. Prior to this pre-development work, an investigation was undertaken between Airbus and Teledyne e2v to review the in orbit data to determine a way to eliminate or mitigate this in a future design. This investigation did not conclude a definitive way to resolve this “hot pixel” issue, however a number of factors were postulated as potential root causes.

A significant potential root cause of these hot pixels is Clock Induced Charge (CIC). Many of the design changes in this pre-development work have therefore been implemented to try to reduce CIC. The detector modifications can loosely be categorized in two ways; those that are general improvements to the detector that enhance its efficacy for the Aeolus-2 mission and those that are specifically trying to eliminate or mitigate the “hot pixels”.

Numerous potential architectures and design options have been evaluated; some of those designs that are being taken forward to manufacture are briefly described below.

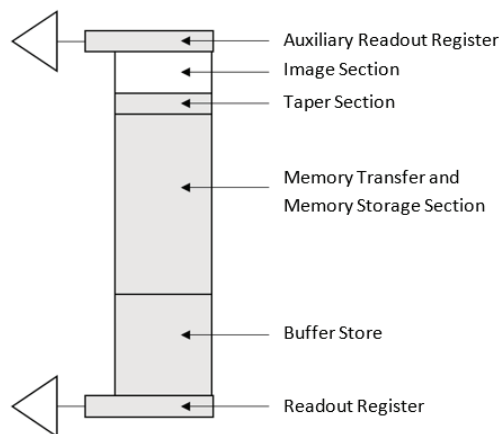

Figure 5.3-1: Outline view of detector architecture

As stated in Table 1 an increase in the number of vertical bins/samples has been requested from 24 to a threshold of 54 or breakthrough of 75. Two detectors (CCD381 and CCD383) have been designed as part of the predevelopment work to enable evaluation of different numbers of vertical samples. CCD381 has 66 vertical bins and CCD383 has 132 vertical bins in the memory transfer and memory storage section. One of the limitations of increasing the number of vertical bins is that the signal charge is shared between even more bins reducing the SNR (Signal to Noise Ratio) of individual bins.

Both the Aeolus and Atlid detectors used a single layer hafnia antireflection coating, optimised for peak Quantum Efficiency (QE) at 355nm (the wavelength of the laser). Thin Hafnia coatings can suffer from sensitivity to humidity leading to a variation in QE. Further development of UV optimised Anti-Reflection (AR) coatings is ongoing at Teledyne e2v and two different AR coatings will be evaluated as part of the development programme. These AR coatings are UV stable with respect to humidity and also have a higher transmission at 355nm than the single layer hafnia coating giving an ~5% to 10% increase in QE.

A buffer store has been added to the development detector below the memory section to allow readout over quiet times between several laser pulses while continuing acquisition. Charge would be transferred from the memory storage section into the buffer store in the period between acquisition of the signals from the last laser pulse of each acquisition and the first laser pulse of the next acquisition. Readout from the buffer store can then be performed independently of the next acquisition as separate clock drives are used for the memory and buffer store sections.

The buffer store allows the readout to be spread over several laser pulse periods, reducing the readout rate and read noise without any need for 'dropped' laser pulses.

An additional (or auxiliary) readout register and output has been implemented in the development detector. This auxiliary readout register is situated at the top of the image section and enables both the local laser echo and the below ground background to be read out without any accumulation. The principal benefit of the auxiliary readout path is that it is expected to significantly reduce the generation of CIC hot pixels in the memory section as it is no longer necessary to clock each laser local echo through the full height of the device.

The inclusion of the auxiliary readout register has removed the need to read data that is not accumulated through the memory transfer section and into the readout register. It is therefore possible to terminate the individual columns of the memory transfer section in individual dump drains in a similar way to the memory transfer register in the ATLID detector. In conjunction with this the number of pixels in the readout register can be reduced to match the number of memory storage section columns. This reduces the register clock frequency required to read out the detector in the available time by a factor of almost 2 with an associated benefit of a reduction in read noise. This also reduces the number of clock cycles and therefore reduces CIC.

In addition to the mitigation of CIC, the Aeolus-2 detectors will be operated at a reduced temperature in order to further reduce thermal noise.

The development detectors are currently undergoing manufacture in Teledyne e2v's Wafer Fabrication Facility. Once they finish the improvements will be tested and evaluated.

6. CONCLUSIONS

Aeolus has successfully demonstrated the measurement concept and associated technologies required for a future DWL operational mission, providing wind measurements for >4 years with positive NWP impacts which are being operationally assimilated by major meteorological centres. Preliminary inputs from EUMETSAT, recommendations from the Aeolus Science Advisory Group, along with lessons learned from the Aeolus development and in-orbit performance have been defined, resulting in the definition of preliminary inputs to an Instrument Consolidation Study, 2 laser transmitter assembly pre-developments, and a detector pre-development. The above provides a very strong foundation for an operational DWL mission in the 2030 to 2040 time frame.

The authors would like to thank the Aeolus Science Advisory Group and the industrial teams involved in the pre-development activities.

REFERENCES

- [1] ESA. (2008). "ADM-Aeolus Science Report, European Space Agency". Available at: <https://earth.esa.int/documents/10174/1590943/AEOL002.pdf>.
- [2] Rennie, M., and L. Isaksen. (2020). "The NWP Impact of Aeolus Level-2B Winds at ECMWF". ECMWF Technical Memoranda 864. <https://dx.doi.org/10.21957/alift7mhr>
- [3] Reitebuch, Oliver, Christian Lemmerz, Oliver Lux, Uwe Marksteiner, Stephan Rahm, Fabian Weiler, Benjamin Witschas, et al. (2020). "Initial Assessment of the Performance of the First Wind Lidar in Space on Aeolus". Edited by D. Liu, Y. Wang, Y. Wu, B. Gross, and F. Moshary. EPJ Web of Conferences 237: 01010. <https://doi.org/10.1051/epjconf/202023701010>.
- [4] Aeolus Science and data quality Advisory Group (Aeolus SAG) (2020) "Aeolus SAG recommendations for operational Doppler Wind Lidar (DWL) observation requirements in the 2030-2040 timeframe", ESA Technical Note: ESA-EOPSM-AEOL-TN-3695
- [5] Didier Morançais, Frédéric Fabre, Martin Endemann, and Alain Culoma "ALADIN doppler wind lidar: recent advances", Proc. SPIE 6750, Lidar Technologies, Techniques, and Measurements for Atmospheric Remote Sensing III, 675014 (3 October 2007)
- [6] G. de Villele, J. Pereira do Carmo, K. Wallace, B. Corselle, T. Belhadj, P. Bravetti, A. Lefebvre, F. Chassat, T. Kanitz, K. Ghose, and C. Haas "ESA Atmospheric LIDAR (ATLID) testing, qualification, and calibration", Proc. SPIE 11852, International Conference on Space Optics — ICSO 2020, 118521J (11 June 2021);